



PIPE WIDE 42

**USER  
MANUAL**

# CONTENTS

Quick setup and wrap guide.....	3
Product package.....	4
Technical specifications.....	5
Usage precautions.....	6
Getting ready for operation.....	7
Connecting the controller.....	9
Controller protective cover .....	10
Underwater usage.....	11
Controller.....	12
Controller settings.....	13
DMX Menu.....	14
User Menu.....	15
User Menu: Separate Mode.....	16
User Menu: DMX_seq.....	18
User Menu: Overdrive mode.....	19
User Menu: Max. Power.....	21
User Menu: Step Change Ratio.....	22
User Menu: Smooth Transition.....	23
User Menu: Reset.....	24
Resetting CRMX network adapter.....	25
Finishing work and packing order.....	26
Warranty.....	27
Storage and maintenance.....	28

## QUICK SETUP AND WRAP GUIDE

### SETUP:

1. Inflate the lamp - press the pump to the valve (page 7, fig.5 ).

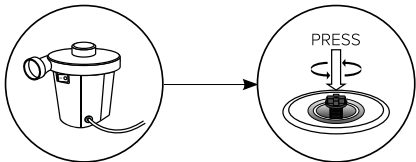

2. Flip the corners, add accessories.

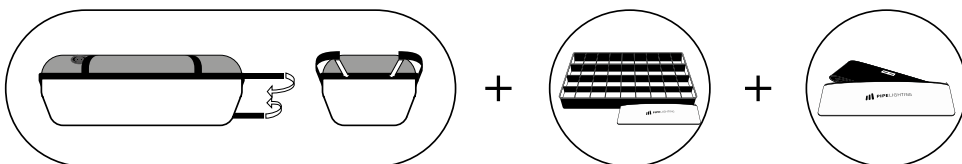

3. Connect the controller (page 9, fig.10-11).

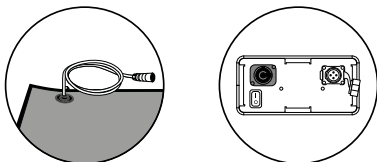

4. Have fun!

### WRAP:

1. Deflate the lamp - open the valve.

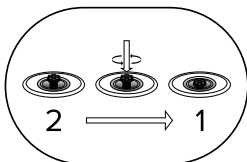

2. Protect with cover.

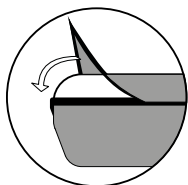

3. Roll the lamp with LEDs inwards.



ROLL WITH  
THE LEDS INWARDS  
ONLY!

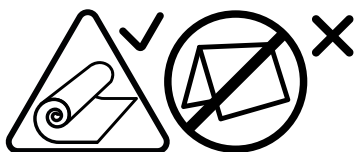

DO NOT FOLD THE LAMP HEAD!



ROLL THE LAMP HEAD  
WITH THE MINIMAL  
INNER DIAMETER 5CM

4. Pack according to packing order (page 26, fig.53 ).

# PRODUCT PACKAGE

Fig. 1. Product package

1. Transportation bags
2. Lamp Head – “PIPE WIDE 42”
3. Mounting frame
4. AC-Cable
5. Extension cable - 5m
6. Controller in bag
7. Air pump
8. Repair Kit
9. Eggcrate (Soft grid) in bag\*
10. Skirt in bag

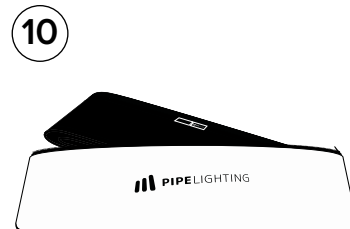
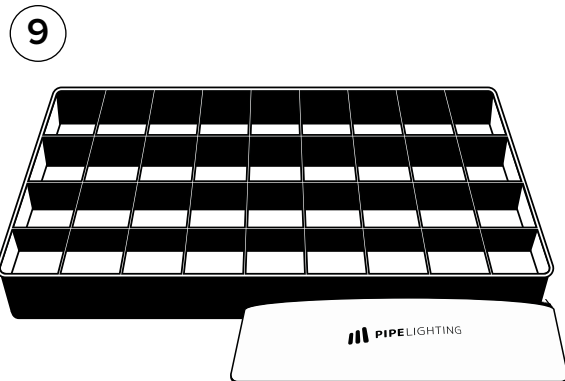
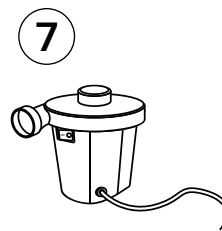
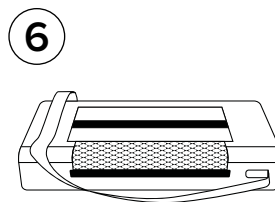
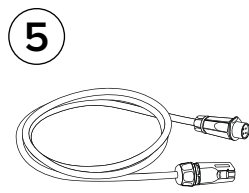
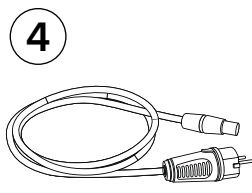
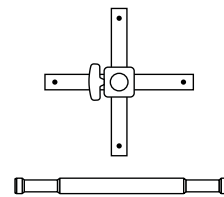
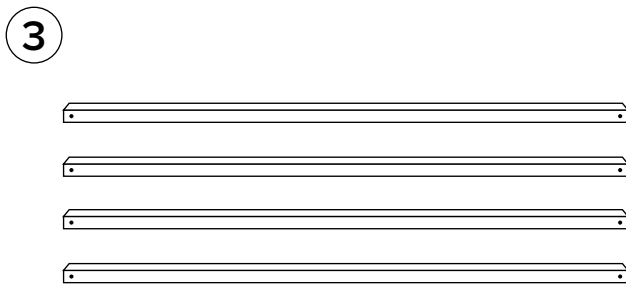
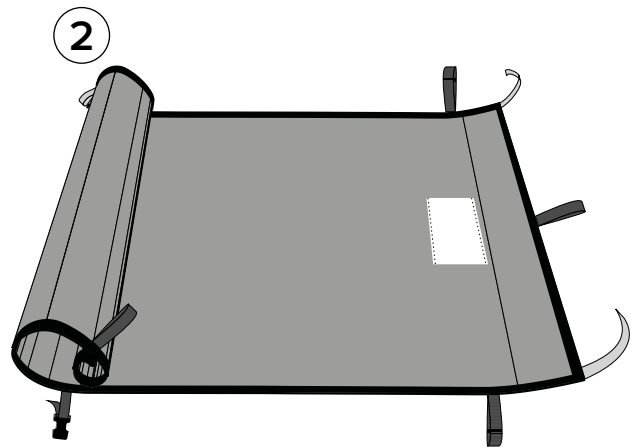
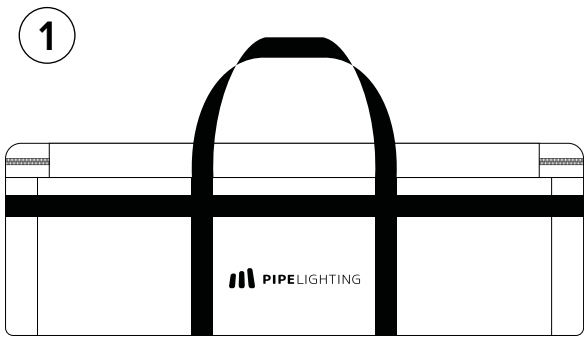

\*provided separately

## TECHNICAL SPECIFICATIONS

Model	PIPE WIDE 42
CCT range, K	2650 – 6400
CRI	96/98
Lamp head size (L × W × H), cm	125 x 60 x 20
Lamp head weight, kg	1,2
Power rating warm channel, W	200
Power rating cold channel, W	200
Total power rating (overdrive), W	400
Operation Voltage, V	220/110
Operating T, °C	Min: -15°C / Max: +40°C
Storage T, °C	15-20°C
Controller IP rating	IP20
Lamp Head IP rating	IP67
DMX settings (510 channels)	1st channel - CCT, 2nd channel - power, 8 bit
Wireless control	Lumen Radio (CRMX)
Transportation bag size (L x W x H), cm	150x25x25, 60x40x25
The whole kit weight with transportation bag, kg	14
Frequency PWM, KHz	128 (flicker free)
Underwater usage up to depth, m	2
Mounting system	16mm baby bin
Cooling	Passive, noiseless
DMX input/output	5pin male/female
Certifications	CE, RoHS
Dimming steps special mode	0,2%
Transition dimming time, ms	0-9999

# USAGE PRECAUTIONS

Fig. 2. Usage precautions



**ROLL WITH THE LEDS INWARDS ONLY!**

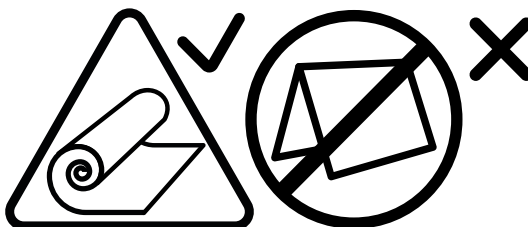

**DO NOT FOLD THE LAMP HEAD!**



**ROLL THE LAMP HEAD WITH THE MINIMAL INNER DIAMETER 5CM**



**DO NOT SMOKE DURING OPERATION!**



**AVOID SHARP OBJECTS!**



**AVOID OVERINFLATING! LAMP HEAD GETS HOT!**



**DO NOT USE THE FIXTURES NEAR HOT SURFACES OR OBJECTS**



**USING THE FIXTURE UNDER DIRECT SUNLIGHT OR HIGH TEMPERATURES (MORE THAN 30°C) CHECK THE PRESSURE!**



**DO NOT TOUCH THE LAMP HEAD WITH DIRTY HANDS! DO NOT WEAR GLOVES!**



**DO NOT FOLD OR STORE WET EQUIPMENT**



**AVOID TENSION ON POWER AND CONTROL CABLES!**

## GETTING READY FOR OPERATION

1. Open the case, take the lamp head with clean hands. Unroll the lamp head on a flat clean surface without any sharp or hot objects (Fig. 3).

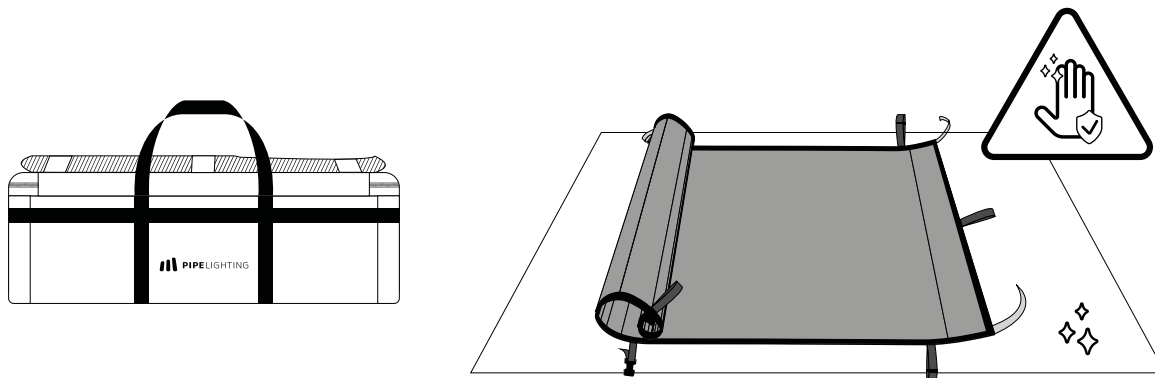

Fig. 3

2. The device can be used both inflated and deflated (Fig. 4).

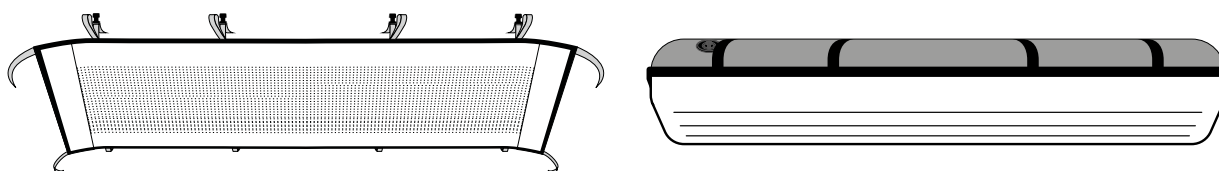

Fig. 4

3. Open the red lid of the overpressure valve (make sure to keep the overpressure valve open during the operation).

4. Inflate the lamp with the provided air pump:

4.1. Open the lid of the air valve.

4.2. Make sure that the air valve button is in **"closed" position**. The positions **"opened"** and **"closed"** are shown in Fig 5.

4.3. Press the air pump against the air valve, turn on the air pump.

4.4. Make sure the lamp head has reached its shape. Do not overinflate!

4.5. Move the pump from the valve and quickly move the button to position **"closed"**.

4.6. If necessary, inflate the lamp head slightly through the closed valve by pressing the air pump against the valve button.

4.7. To release pressure, push the valve button.

Fig. 5

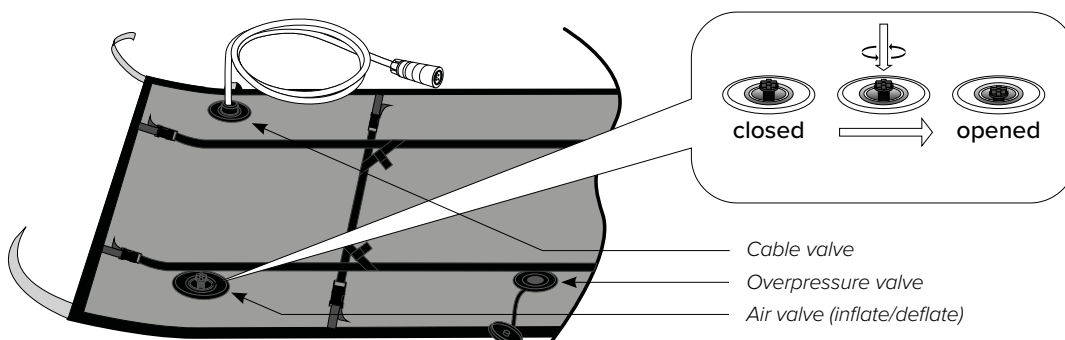

## GETTING READY FOR OPERATION

5. Fold the corners of the lamp head with Velcro to the end face, fasten with Velcro as shown in Fig.6.

Fig. 6

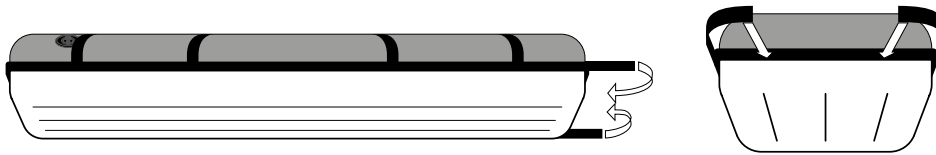

6. Spread out the mount net. Insert the rods into the net sockets (action 1 on Fig. 7).

7. Connect the rods with the cross holder (action 2 on Fig. 7). Adjust the fastening straps on the rear side of the device (action 3 on Fig. 7).

Fig. 7

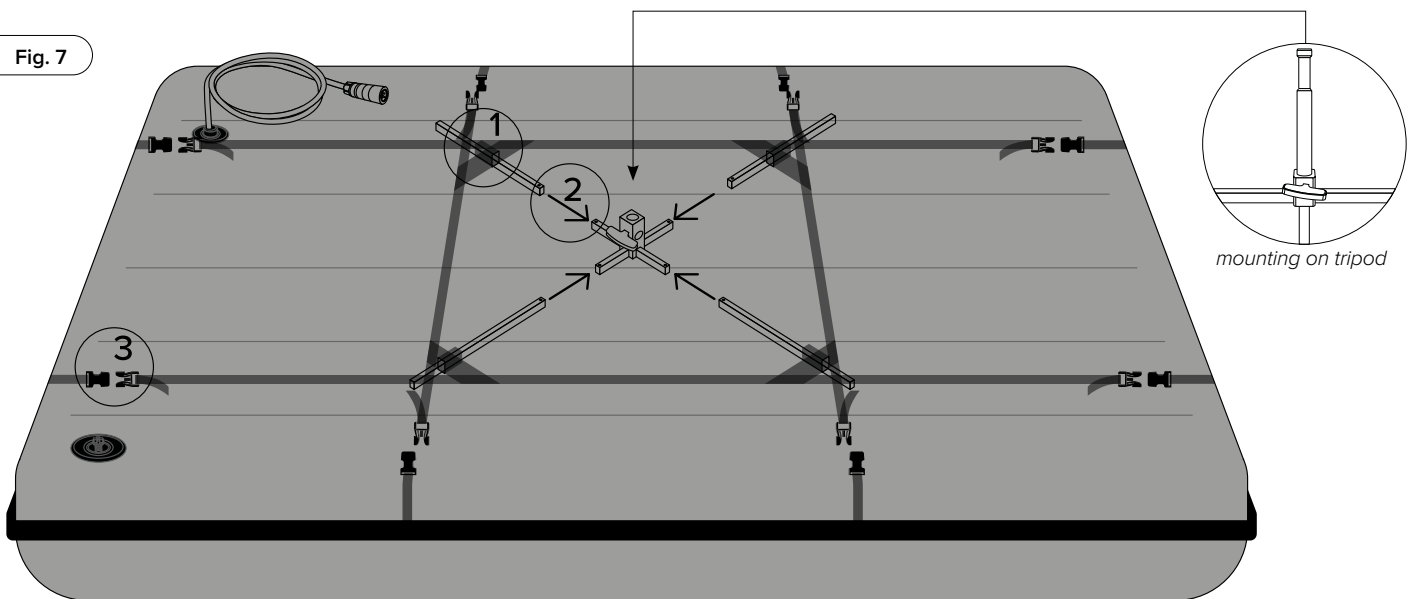

8. Fix the lamp head in operating position on the tripod.

9. Remove the protective cover from the lamp head. Carefully fold the protective cover with the clean side inwards and put it into the bag (Fig.8).

Fig. 8

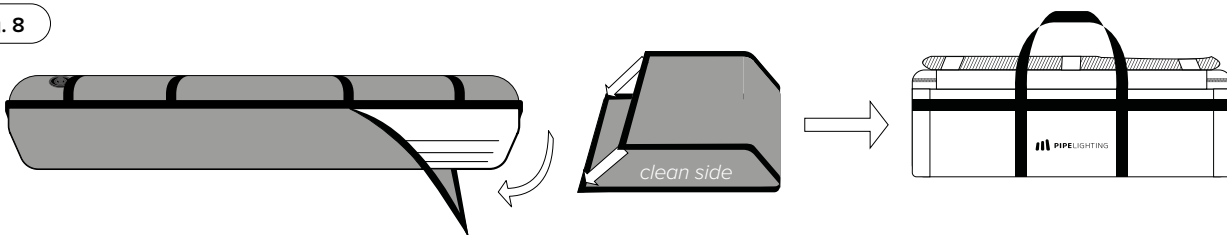

10. If necessary, attach a soft grid/eggcrate and/or skirt (included) to the lamp head.

11. Check the tightness of the nut of the cable valve on the lamp head from time to time. Tighten with handpower only! Do not use wrench! (Fig.9)

Fig. 9

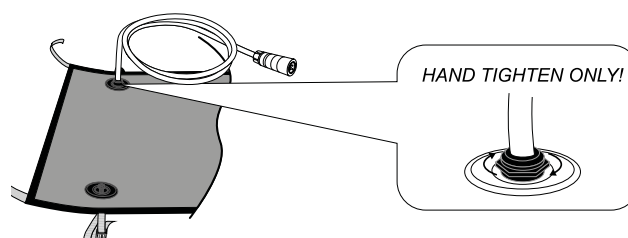



## CONNECTING THE CONTROLLER

1. Align the connectors of the signal cable and the controller as shown in Fig.10.

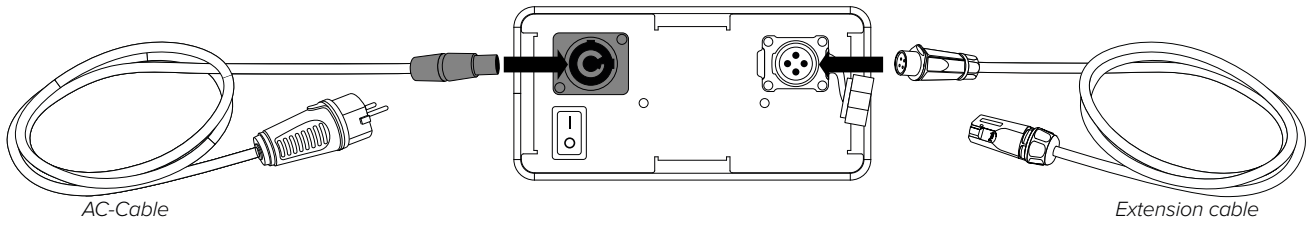

Fig. 10

2. Connect the power AC-cable to the connector on the body and the 220/110V socket.
3. Switch on the controller (Fig.11).

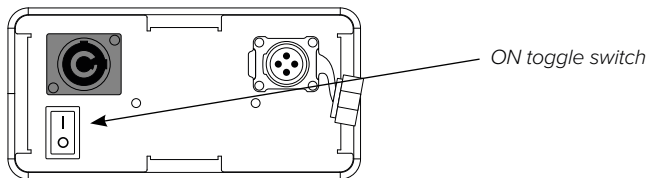
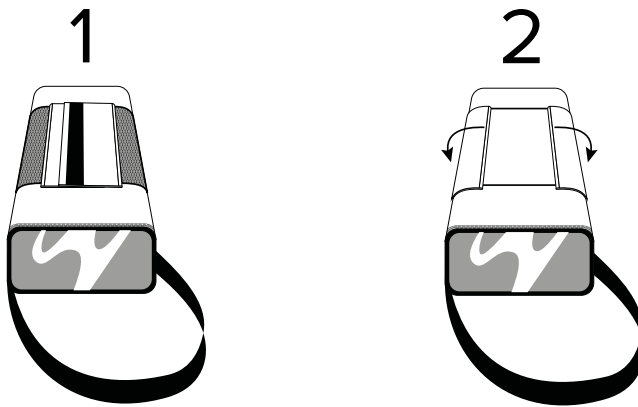

Fig. 11

## CONTROLLER PROTECTIVE COVER

The controller protective cover has two operating positions. Position **1** (Fig. 12) with air vent open is the main operating position. When used outdoors during rainfall, the flaps of the cover should be folded to position **2** (Fig. 12).

Fig. 12



It is also possible to use the flaps to form a mounting bracket with which the controller can be mounted on a tripod (Fig. 13).

Fig. 13

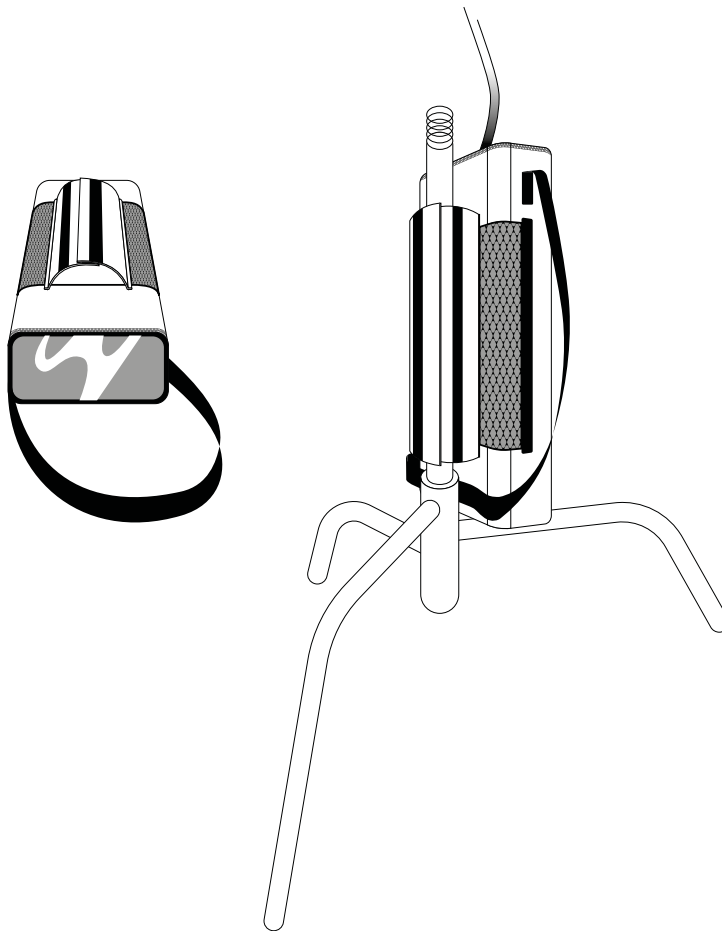

## UNDERWATER USAGE

THE UNDERWATER USAGE IS NOT THE MAIN PURPOSE OF THE PIPE LIGHTING LAMP HEADS. PLEASE MAKE SURE TO READ THESE INSTRUCTIONS BEFORE UNDERWATER USAGE.

Please take all the air out of the fixture with the back side of the air pump. Make sure to fix the lamp head properly under water using weights and/or frame.

Maximum guaranteed water depth: 2m.

**ATTENTION: MAKE SURE OVERPRESSURE CAP IS CLOSED, THE AIR VALVE IS IN "CLOSED" POSITION, THE CAP OF THE VALVE LOCKED ON THE LAMP HEAD!**

**DANGER OF MOISTURE ENTERING THE LAMP HEAD!**

**THE CABLE CONNECTOR MUST STAY ABOVE THE WATER SURFACE! (FIG.14)**

Test the lamp head shortly near the water surface by dipping it shortly into the water before submerging it deeper! Before packing, please dry the lamp head properly.

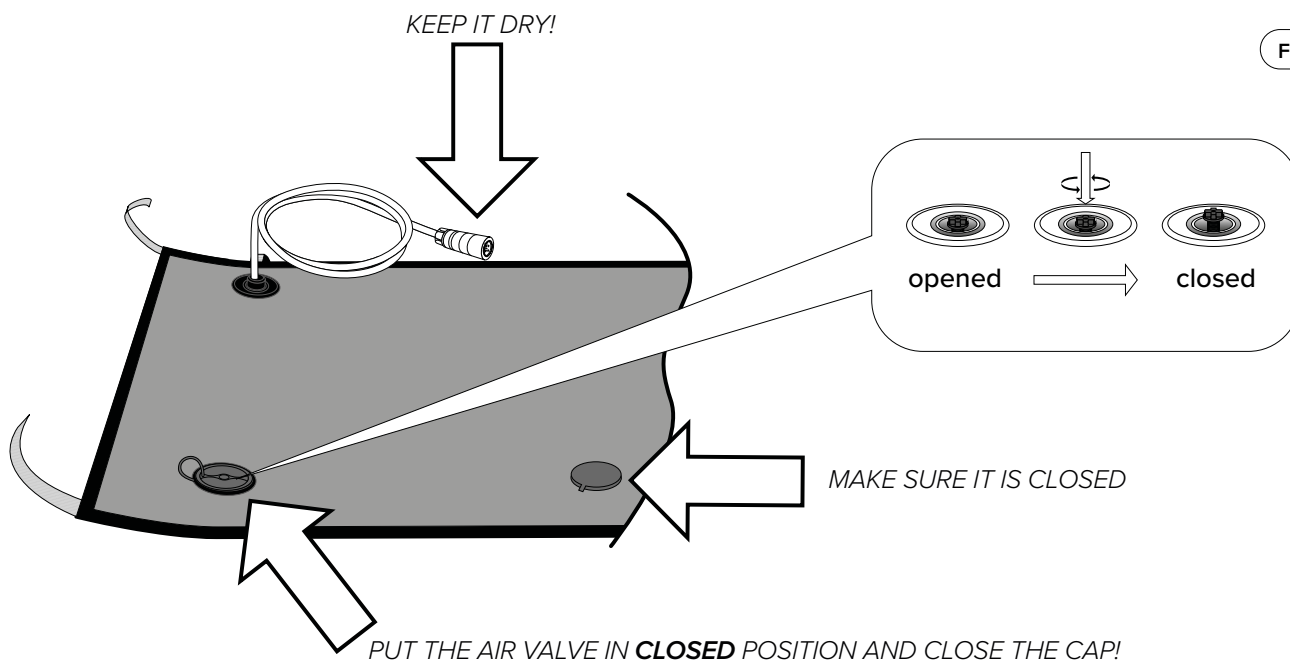
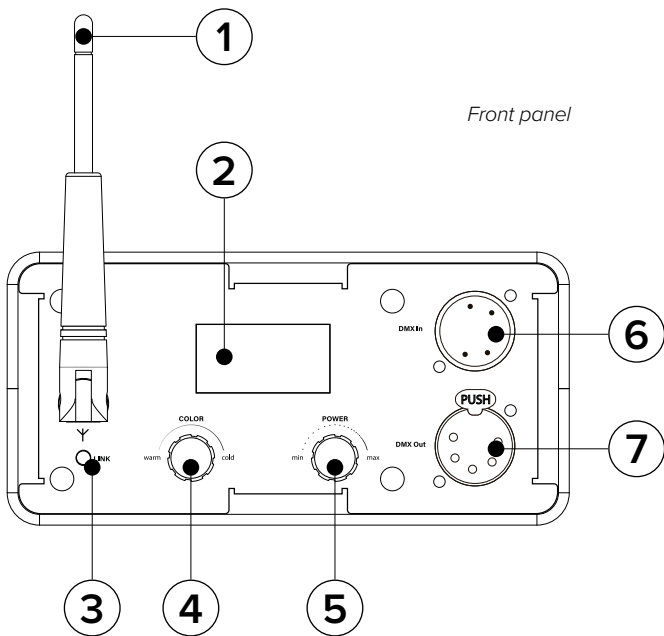
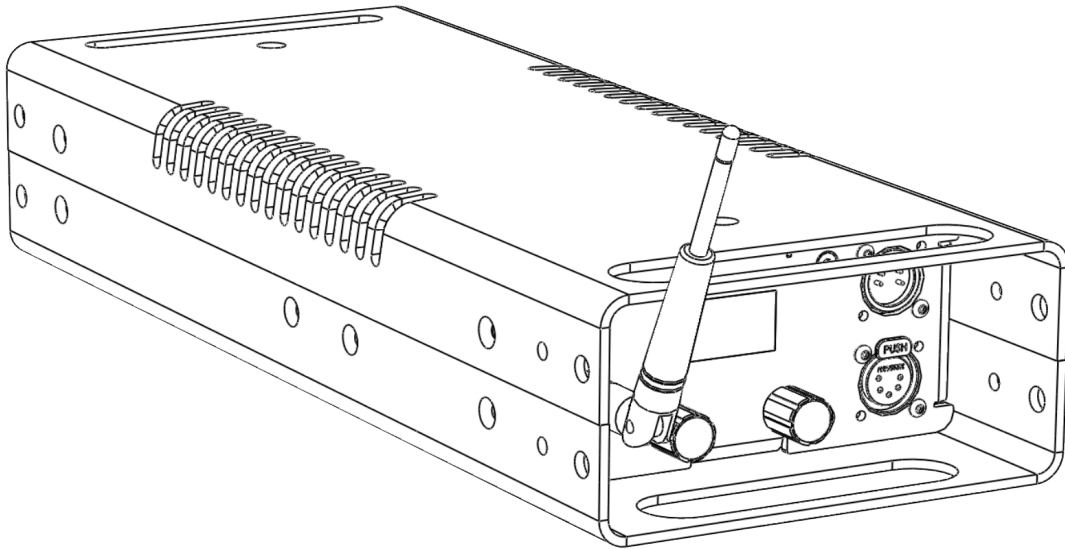

Fig. 14.

# CONTROLLER

Fig. 15. Controller

General view



Front panel

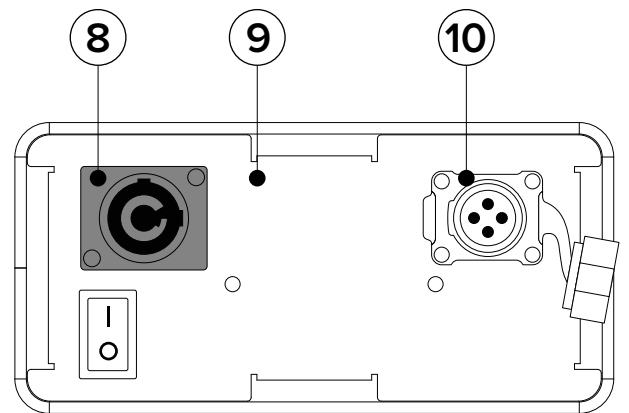

Rear panel

- 1. CRMX antenna
- 2. OLED Display
- 3. Link Button
- 4. Color Encoder
- 5. Power Encoder
- 6. DMX Input
- 7. DMX Output
- 8. Power Input
- 9. Power Switch
- 10. LED Output

## CONTROLLER SETTINGS

1. After switching the unit on, you will see the main screen (Fig.16).

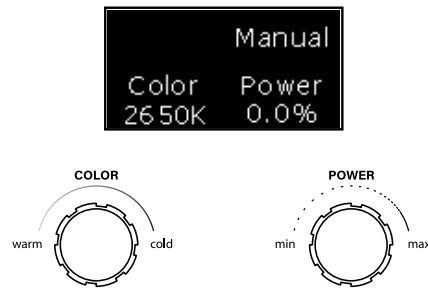

Fig. 16

2. The left encoder controls the color temperature. The right encoder controls the brightness of the unit (Fig. 17).

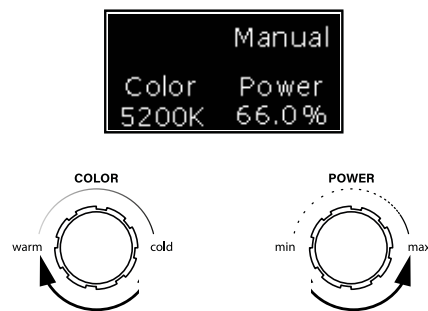

Fig. 17

3. Pressing on the right encoder shows the internal temperature of the controller (Fig. 18).

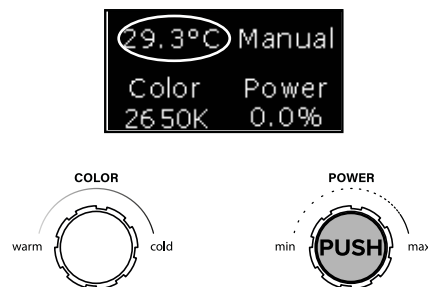

Fig. 18

## CONTROLLER SETUP / DMX MENU

The DMX address must be set to control the unit remotely. The address has the same value for both wired and wireless **DMX**. Pipe Lighting controller uses 2 DMX-channels (except in Separate Mode): one for the color temperature and one for the brightness.

1. Pressing on the left encoder brings up a menu to enable **DMX** control and set the devices DMX address (Fig.19).

Fig. 19

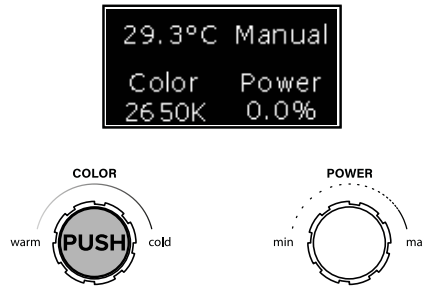

2. Rotating the left encoder toggles to the parameter edit mode (Fig.20).

Fig. 20

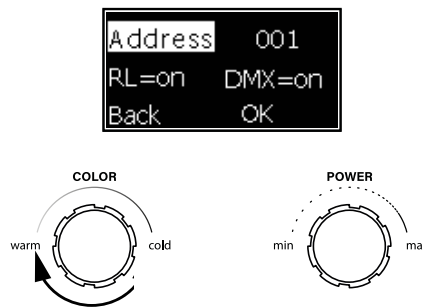

3. Pressing on the left encoder will switch to the DMX address editing mode. The address can be set in the range from 1 to 510. Confirmation of the selection is made by pressing the left encoder again.

The RL parameter enables/disables the radio control of the unit.

The DMX parameter enables/disables the wired DMX control of the unit.

Selecting Back returns to the main screen without changing any parameters.

Selecting OK saves the changes made to the parameters and returns to the main screen. (Fig.21).

Fig. 21

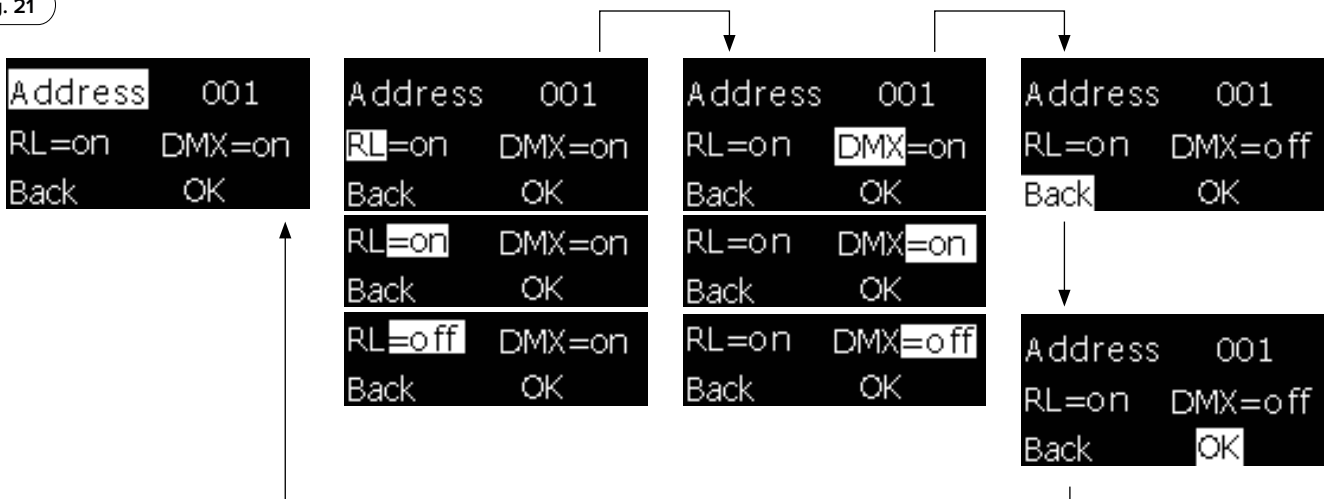

The **User menu** provides access to the parameters for different operation modes and features of the controller (Fig.22).

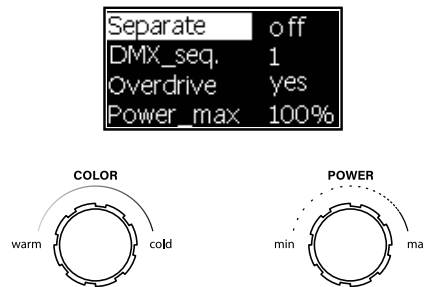

Fig. 22

To access the **User menu**:

1. Switch off the device.
2. Press and hold the left encoder button.
3. Turn on the power to the controller while holding down the left encoder button.
4. Release the left encoder button when the current firmware number is shown on the LCD screen.

**Separate mode** is mode in which two channels act independently of each other.

1. Pressing on the left encoder brings up the menu to enable/disable the **Separate mode** (Fig. 23).

Fig. 23

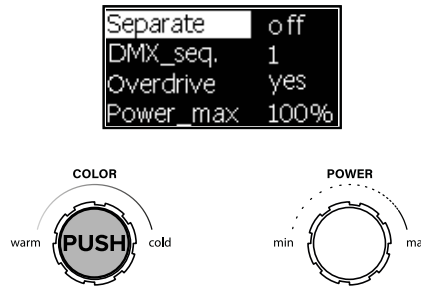

2. Rotating the left encoder knob toggles between the menu items. Pressing confirms the selected option (Fig.24).

Fig. 24

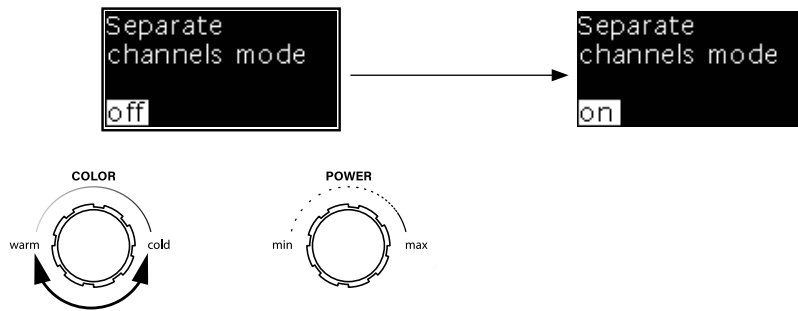

3. After returning to the **User menu**, select **Exit** to save the settings (Fig.25).

Fig. 25

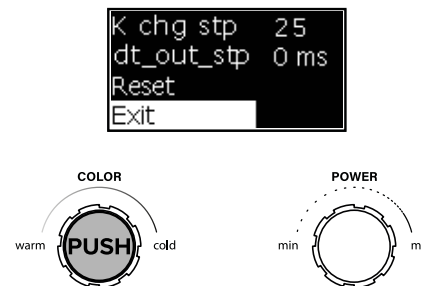

4. Now you are using the **Separate mode** (Fig.26).

Fig. 26

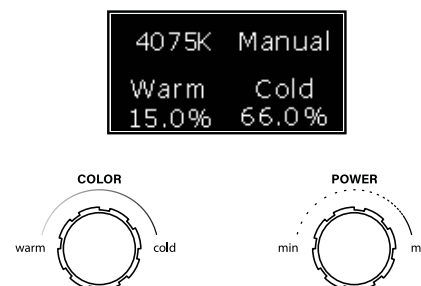

The left encoder controls the brightness of tunsten LEDs. The right encoder controls the brightness of daylight LEDs (Fig.27).



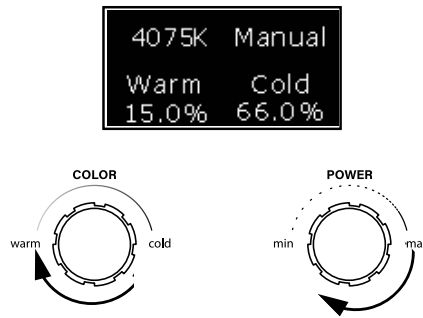

Fig. 27

The upper left corner shows the actual color temperature in K (Kelvin). The temperature is calculated automatically according to the calibration of the unit and the set tungsten to daylight LED ratio (Fig.28).

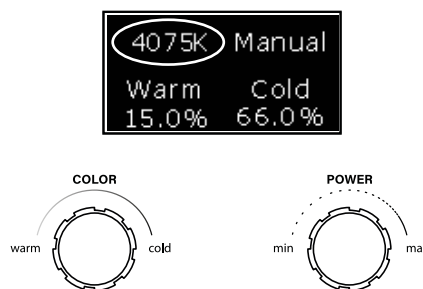

Fig. 28

The maximum power of the two groups of diodes is not limited. Each group can be set to 100% (Fig. 29).

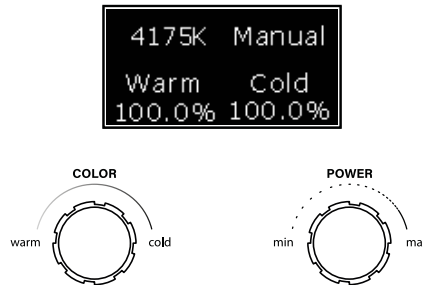

Fig. 29

When controlling via **DMX** in **Separate** mode 3 addresses are activated:

- brightness of tungsten diodes,
- brightness of daylight diodes,
- common virtual CONTROLLER (see **DMX\_seq** parameter).

1. Pressing on the left encoder brings up a menu for setting the channel addressing sequence (see **DMX Addressing**) (Fig.30).

Fig. 30

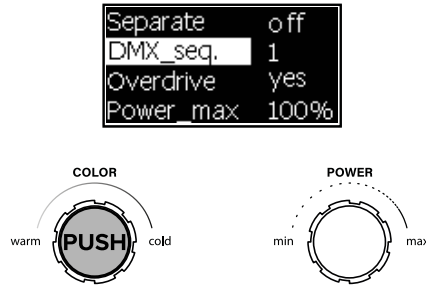

2. Rotating the left encoder toggles between valid parameter options (Fig. 31).

Fig. 31

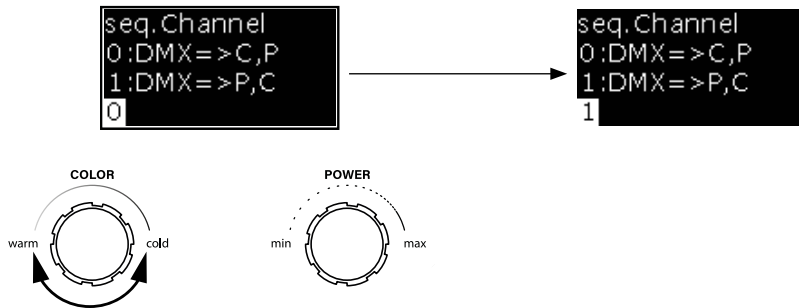

3. After returning to the **User menu** select **Exit** to save the settings(Fig. 32).

Fig. 32

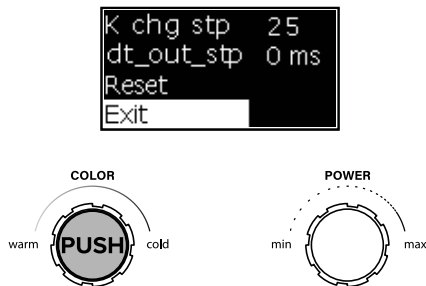

1. Pressing on the left encoder calls the **Overdrive** menu (Fig.33).

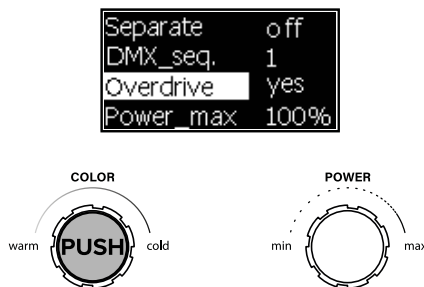

Fig. 33

2. Rotation of the left encoder toggles between the menu options. Pressing the encoder confirms the selected parameter (Fig.34).

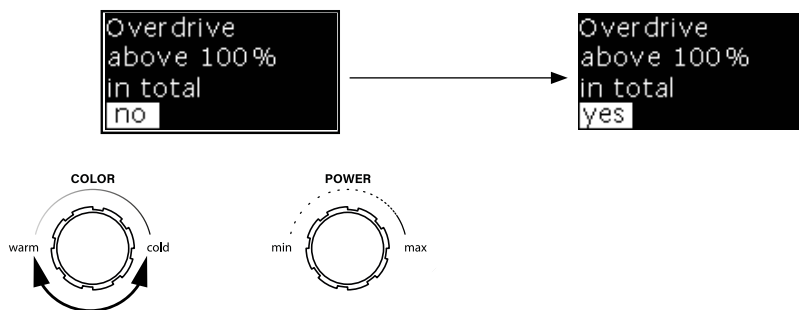

Fig. 34

3. After returning to the **User menu**, select **Exit** to save the settings (Fig. 35).

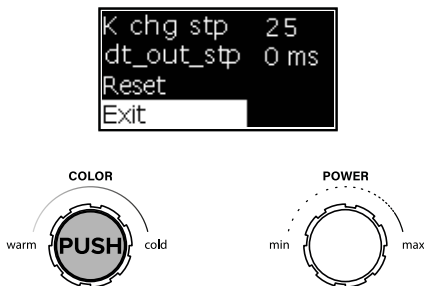

Fig. 35

4. After restarting the device the main window will switch to the **Overdrive mode**. In this mode it becomes possible to turn on both control channels at 100%, which in total makes 200% in the middle of the color temperature range at 4175 K (Fig.36).

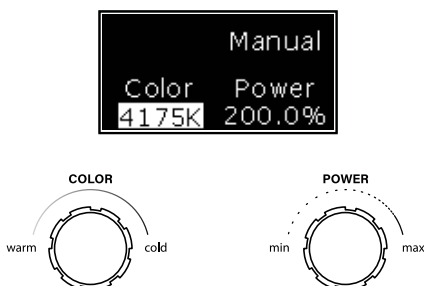

Fig. 36

In **Overdrive mode** the maximum potential of diodes of the unit is used. Each of the control channels can be set from 0% to 100%, depending on the required color temperature.

A different maximum luminous power can be reached for each color temperature value. If at the extremes of the range the maximum achievable power is still 100%, then in the middle of the range it reaches 200% (both channels operating at full power).

The graph below shows the relationship between the maximum power of the device and the width of the color temperature control range (Fig. 37).

**Fig. 37**

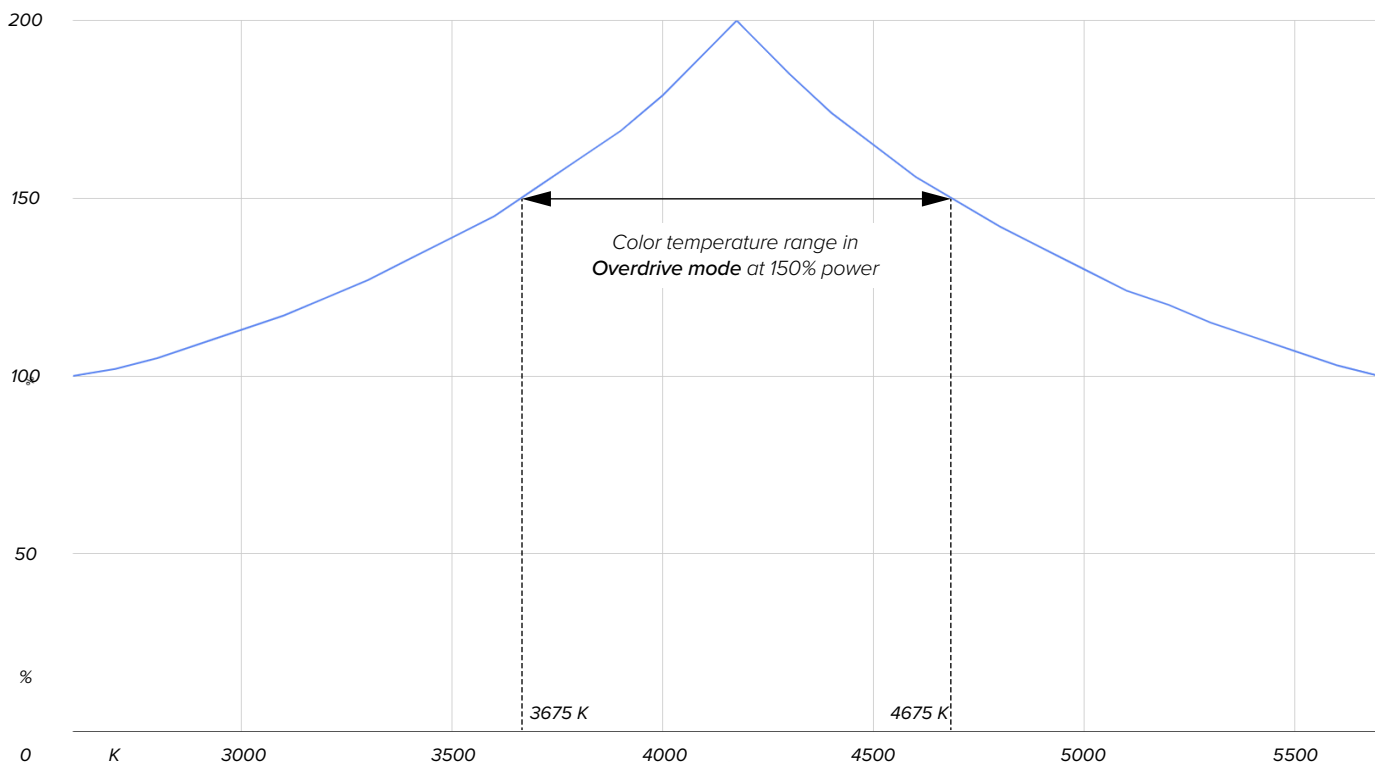

Reaching 200% maximum power is only possible in the middle of the color temperature range. To simplify the search, the middle of the range is invertibly illuminated (Fig. 38).

**Fig. 38**

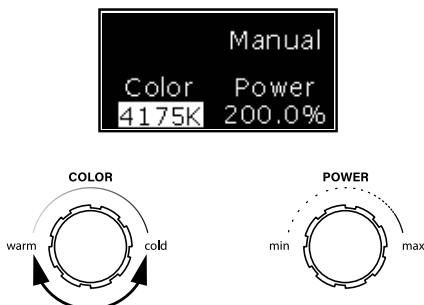

1. Pressing on the left encoder brings up a menu for selecting the **Power\_max** parameter value (Fig.39).

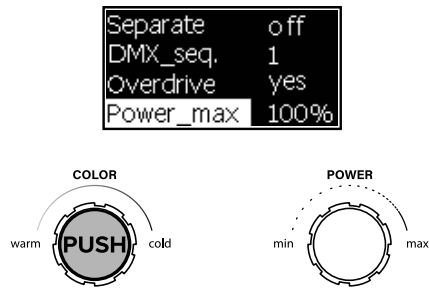

Fig. 39

2. You can turn the left encoder and toggle between the menu options. Pressing confirms the selected parameter (Fig.40).

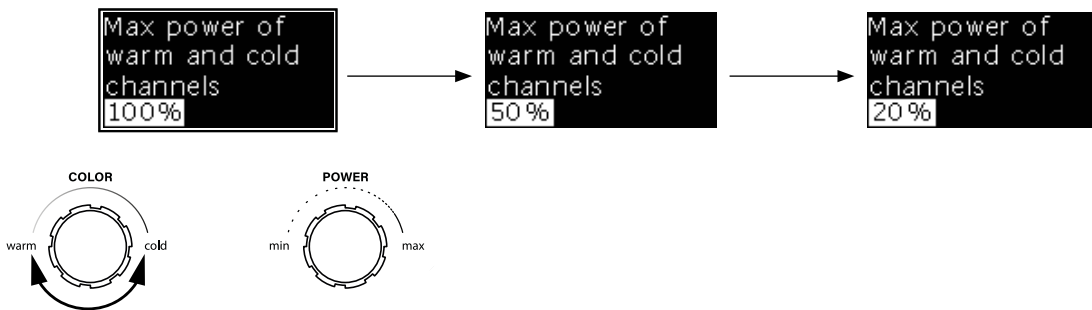

Fig. 40

3. After returning to the **User menu**, select **Exit** to save the settings (Fig.41).

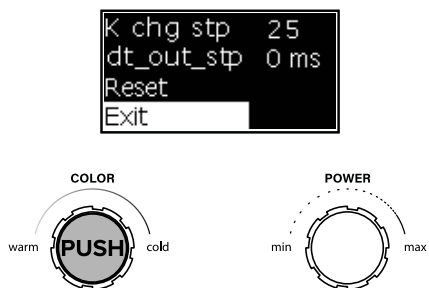

Fig. 41

The main window will switch to the **Power\_max mode**.

In **Power\_max mode** the power is limited to the selected parameter. At the same time it is possible to adjust the power in steps of 0,2% and 0,5%, including around the zero mark (Fig.42).

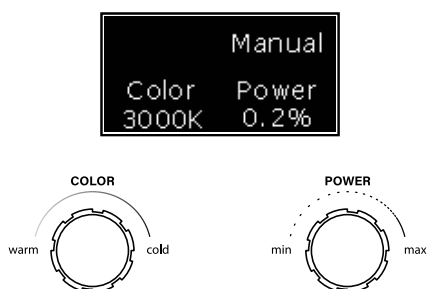
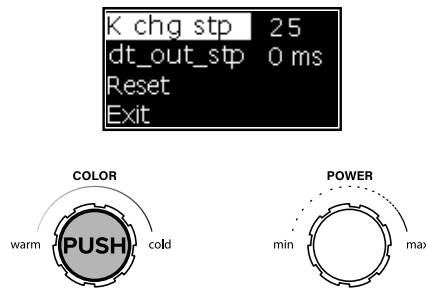

Fig. 42

1. Pressing on the left encoder displays the menu of the **K\_chg\_stp** parameter value selection (Fig. 43).

Fig. 43



2. Turning the left encoder toggles between the menu options, allowing temperature step values: 10, 25, 50, 100 (Fig.44)

Fig. 44

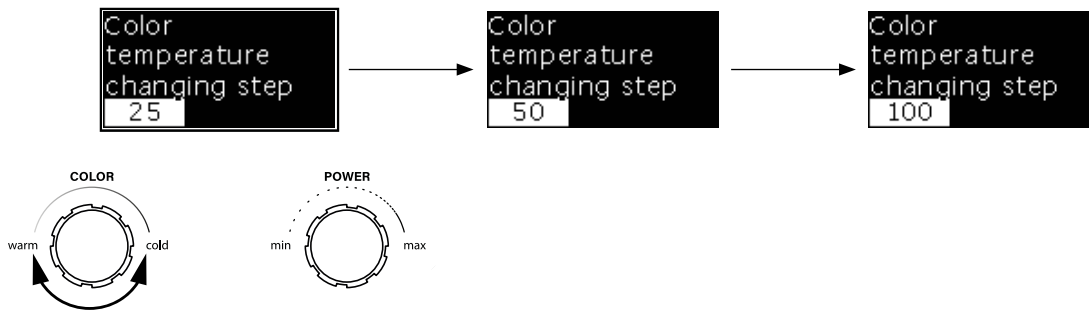

3. After returning to the **User menu** select **Exit** to save the settings (Fig.45).

Fig. 45

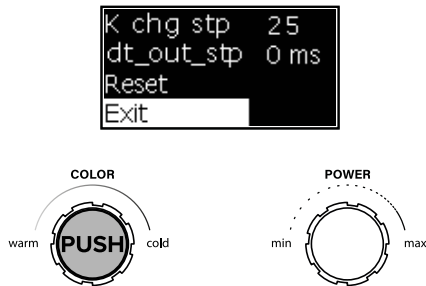

1. Pressing on the left encoder displays the menu to select the values of parameter **dt\_out\_stp** (Fig.46).

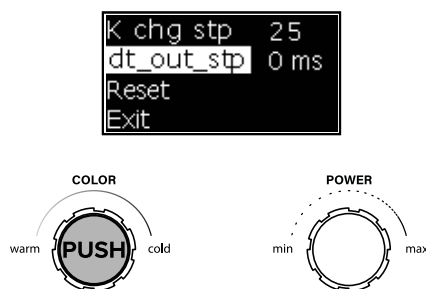

Fig. 46

2. When **dt\_out\_stp** is set to 0 ms, the transitions between the different controller parameter states are instant and you can visually see a step change in brightness and temperature at low power values. Rotation of the left encoder knob changes the parameter which represents the time of smooth transition between states in milliseconds. It is possible to set the transition time from 1 ms to 9999 ms (Fig.47).

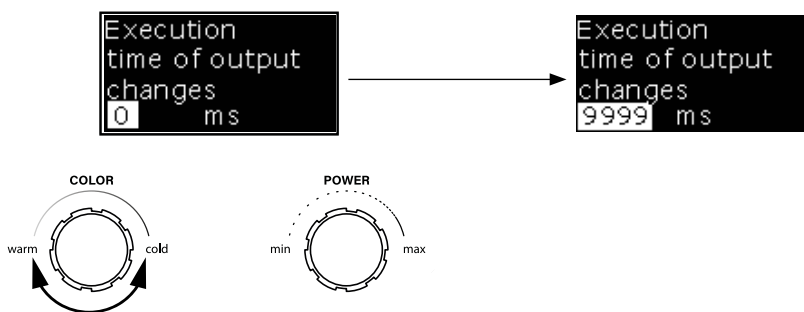

Fig. 47

3. After returning to **User menu** select **Exit** to save the settings (Fig. 48).

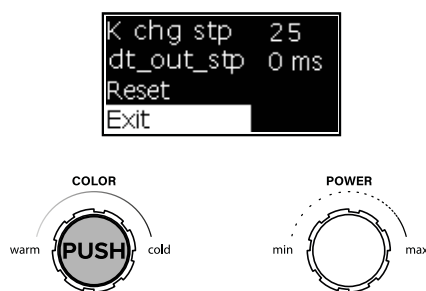
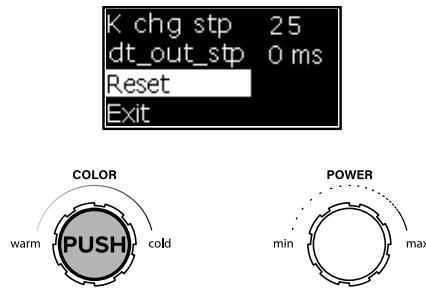

Fig. 48

1. Pressing on the left encoder resets all the controller settings to the factory settings. The calibration factors are set to default corresponding the model (Fig.49).

Fig. 49





## RESETTING CRMX NETWORK ADAPTER

PipeLighting dimmers use a built-in LumenRadio® radio module with CRMX protocol. In case of signal loss or connection failure it is necessary to reset the network adapter of the device. To do so, press and hold for 5 seconds the "Link" button under the antenna on the front panel of the dimmer, when the device is switched on (Fig. 50). It is necessary to search again (Link) the device on your CRMX router. For stable operation, we recommend using the light control panel from Gaffers Control®.

Fig. 50

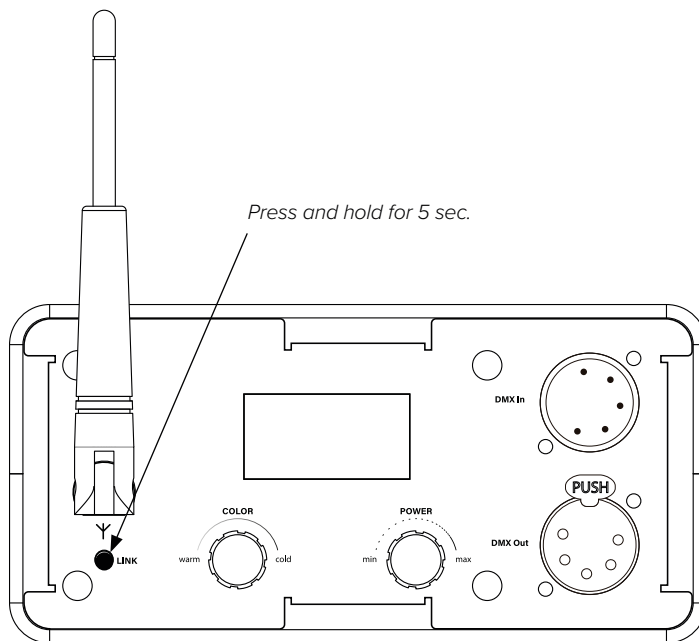

## FINISHING WORK AND PACKING ORDER

1. Before you start packing, make sure that the unit is complete.
2. Unplug the unit from the power outlet. Disconnect all wires from the controller and put the controller in the case first.
3. Carefully roll up all cables and put them in the case as well.
4. With clean hands, place the protective cover over the head of the unit.
5. Remove the lamp head from the tripod and place it on a clean surface.
6. Disconnect the straps of the mounting pad.
7. Deflate the lamp head with the supplied pump. Do not close the air valve in the deflated lamp head.
8. Remove the attachment straps.
9. Spread the head of the lamp head and make sure there are no wrinkles.
10. **Roll up the lamp head into a roll with an inner radius of at least 5 cm (Fig. 51).**

Fig. 51

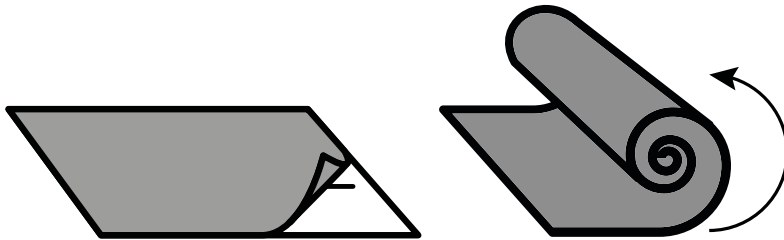

11. Stack the accessories in the case only in the order shown in Fig. 52:

1. Controller.
2. Air pump.
3. AC-cable.
4. Extension cable.
5. Skirt in bag.
6. Mount frame in bag.
7. Lamp head (rolled with 5 cm in diameter).
8. Soft grid in bag (if it is provided).

Fig. 52

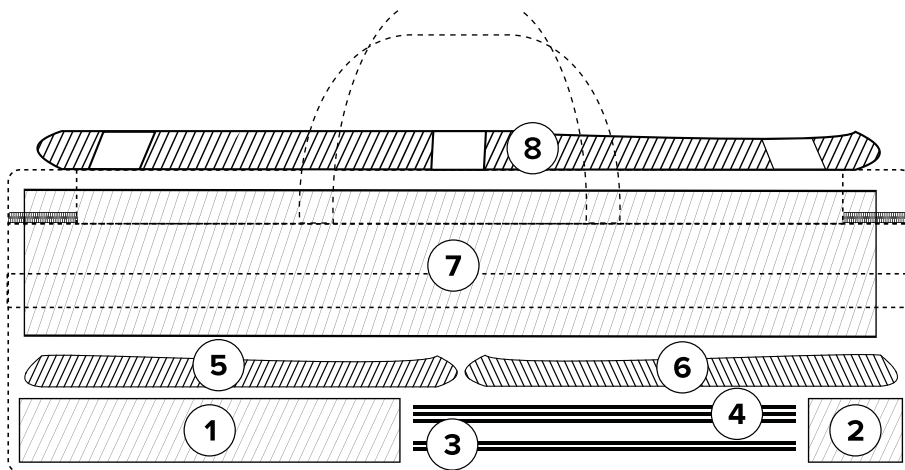

## WARRANTY

*The Supplier's warranties are valid for 12 (twelve) months from the date of delivery for the new Goods. The Supplier guarantees stable operation of the Goods during the warranty period if the Buyer fulfils the conditions of the Goods operation.*

*In case of non-compliance of the Goods with the declared technical requirements or after the Buyer's expertise on the presence of implicit causes and detection of a manufacturing defect, the Supplier is obliged to eliminate the detected defects or replace the Goods with a new one during the warranty period.*

*If the Goods are found to be defective or unusable, the Supplier is obliged to accept the Goods for exchange within 4 (four) weeks from the date of receipt of the claim. The Supplier is obliged to provide return delivery within 4 weeks after determining further actions on repair or replacement of the Goods.*

*The Buyer shall send the Goods to the Supplier at its own expense. The Supplier shall carry out a technical examination of the Goods and reasonably determine the cause of the defect. In case of a manufacturing defect, the Supplier shall send to the Buyer, at its own expense, a corrected or new Goods, and the Buyer's shipping costs shall be credited to the Supplier's deposit account, from which subsequent purchases shall be paid.*

*The Supplier's terms and conditions are valid. Each Goods are accompanied by detailed instructions in English, including technical specifications with recommended temperature settings and IP rating, and a set of pictograms illustrating proper use and precautions. It is the Buyer's responsibility to familiarise himself with these instructions and these Warranty conditions and to pass them on to third parties when the Goods are used by third parties.*

*Use of the Goods beyond the limits recommended in the enclosed instructions, in particular: moisture penetration into the Goods, use of the Goods in conditions of high humidity in aggressive environments, or under water, dropping the Goods from a height, placing heavy objects on the Goods, use of the Goods outside the declared temperature ranges, in the open sun, in conditions of sharp temperature changes, near strongly heated surfaces and open fire, mechanical damage to the case, electromagnetic impact beyond the EMC standards of the country of use of the Goods, improper electrical connection, use of the Goods with incomplete equipment, together with devices of third-party manufacturers.*

*Non-warranty cases in relation to the lamp head: mechanical damage to the lamp head (cut, puncture, melt, etc.) Also non-warranty cases include damage to the seams of the device caused by leaving in the open sun, installation near heated objects, open window, ingress of aggressive liquids, improper storage conditions and improper packing in the case (not arranged according to the scheme, the lamp head is folded, not rolled, etc.)*

*The Supplier shall not be liable for damages resulting from improper use of the Goods.*

*If the Goods are found to be defective during inspection or subsequently, the Supplier must be notified in writing within 2 weeks after receipt of the Goods.*

*In this case the Supplier's liability for a defect that has not been notified in a timely and correct manner is excluded in accordance with statutory regulations.*

*If after an expert examination carried out by the Supplier it is established that the delivered goods have manufacturing defects, the Supplier may choose whether to proceed by removing the defect (repair) or by delivering the goods without defects (replacement).*

*In this case, the Supplier has the right to refuse the subsequent fulfilment of obligations in accordance with the statutory conditions.*

*In the case of a warranty claim, the costs necessary in connection with the examination and subsequent performance, in particular in particular transport, travel, labour and material costs (not: dismantling and installation costs) shall be borne by the Supplier.*

*If it turns out that the Purchaser's claim for rectification of the defect is unreasonable, the Supplier reserves the right to demand reimbursement of the costs incurred from the Purchaser.*

## STORAGE AND MAINTENANCE

If the lamp head was contaminated during the work, simply use the wet rag to wipe all the dirt and dust. In case of more serious contamination (oils, other liquids or materials) use the soft rag and acetone to clean the surface. You do not need to rinse the acetone.

In case if the lamp head textile was pierced, cut or somehow damaged, simply stick one of the stickers from the Repair Kit to cover the hole.

Make sure, the place, where the sticker would be applied, is clean and dry.

You do not need any additional devices as iron to put the sticker – it is self adhesive.



**Made in Germany**

**Pipe Lighting GmbH  
Luisenweg 109  
20537 Hamburg, Germany**

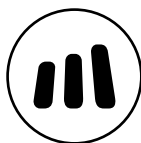

+49 151 299 31 049  
+49 40 723 77 273



**[info@pipelighting.com](mailto:info@pipelighting.com)  
[www.pipelighting.com](http://www.pipelighting.com)**